

ZHB

FLEXIBLE LED HIGH BAY LUMINAIRE

PROJECT

DATE

TYPE

NOTES



REV: 08 2020



IP66 HEAVY-DUTY HOUSING

The ZHB is constructed with Die Cast Aluminum End-Caps and Individually sealed LED Modules to create a Heavy-Duty Housing

FLEXIBLE LIGHT OUTPUT CONFIGURATIONS

Extensive offering of Wattage, Optics and CCT options allow the ZHB to meet a wide-range of project requirements

EASY TO INSTALL MOUNTING HARDWARE

The ZHB comes standard with a Eye-Hook Mounting Bracket engineered to be installed within a variety of High-Bay Applications; 12" & 18" Pendant Mounts are available as an option

120-277V STANDARD

PRODUCT APPLICATIONS

Warehouses	Gymnasiums
Industrial Buildings	Rec Centers/Arenas
Shipping Centers	Cold Storage

When Specifying Options, Please Check with Factory for Availability and Lead-Time. Any finish other than Paraflex bronze order is non-cancelable and non-returnable. Any modified product, any selected options added to standard products, deem order non-cancelable and non-returnable. All RMA, Return Material Authorization, must be factory approved.

ORDERING GUIDE

Sample Part # ZHB - 100W - 40K - T1 - BZ - MS1 - D1

MODEL	WATTAGE	CCT	OPTICS	HOUSING COLOR	OPTIONS & ACCESSORIES
ZHB					
	60W 60 WATTS	30K 3000K - WARM WHITE	T1 TYPE I	BZ BRONZE (STANDARD)	PC 0.3 PIN, 120V-220V PHOTOCELL
	100W 100 WATTS	40K 4000K - NEUTRAL WHITE	T2 TYPE II	WH WHITE	MS1 MOTION SENSOR WITH DIMMING
	120W 120 WATTS	50K 5000K - COOL WHITE	T3 TYPE III	BL BLACK	MS2 MOTION SENSOR ON/OFF ONLY
	150W 150 WATTS	57K 5700K - DAYLIGHT	T4 TYPE IV	SL SILVER	D1 0-10V DIMMING
	200W 200 WATTS		20D TYPE V - 20° BEAM ANGLE		SGS SIDE GLARE SHIELD SET (Factory Installed only)
	250W 250 WATTS		40D TYPE V - 40° BEAM ANGLE		FBGS FRONT & BACK GLARE SHIELD (Factory Installed only)
	300W 300 WATTS		80D TYPE V - 80° BEAM ANGLE		WG PROTECTIVE WIRE GUARD
			170D TYPE V - 170° BEAM ANGLE		EM EMERGENCY BATTERY BACKUP
					SC SAFETY CHAIN
					P1 12" PENDANT MOUNT
					P2 18" PENDANT MOUNT
					NC1 NETWORK CONTROLS FOR ZIGBEE
					V1* 480/347V INPUT (120-277V STANDARD)

*NOT AVAILABLE WITH A PHOTOCELL, EM OR MOTION SENSOR

PRODUCT SPECIFICATIONS

WATTAGE	DELIVERED LUMENS	EFFICACY	MODULES	X WIDTH
60W	7,380 LM	123 LM/W	2	10.7"
100W	12,300 LM	123 LM/W	3	13.5"
120W	14,760 LM	123 LM/W	4	16.3"
150W	18,450 LM	123 LM/W	5	19.1"
200W	24,600 LM	123 LM/W	6	21.9"
250W	30,750 LM	123 LM/W	7	24.7"
300W	36,900 LM	123 LM/W	8	27.5"

Notes
Lumen Data shown for 5000K and 80° Beam Angle

PRODUCT DIMENSIONS

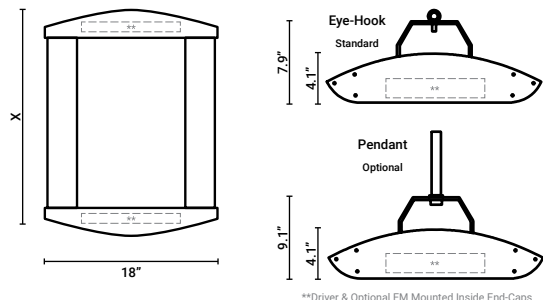

**Driver & Optional EM Mounted Inside End-Caps

PARAFLEX does not warrant or represent that the information is free from errors or omission. The information may change without notice and PARAFLEX is not in any way liable for the accuracy of any information printed and stored or in any way interpreted or used.

PRODUCT SPECIFICATIONS (CONT.)

IP66 HOUSING

Body is comprised of heavy duty die cast end caps with extruded aluminum sides connecting them. As the fixture increases in wattage, the extruded portions become longer to accommodate additional LED modules. The driver is housed inside one of the end caps. Since the LED modules and driver are all individually sealed, the entire fixture is vented to improve thermal dissipation. A 6' 18/3 power supply cord is standard on all models.

IP66 OPTICS

The LED modules are individually sealed, with each board mounted directly to a heat-sink and lens

LENS CONSTRUCTION

The lens is made of molded acrylic and also acts as the primary optic for the fixture

DIMENSIONS

Fixed size for the end caps, variable size depending on wattage (number of modules) for the extruded sides

FINISH

Exterior rated powder coat. Available in standard Bronze, Silver, White, Black, or in a Custom Color

WARRANTY

10-Year Limited Warranty

LEDS

Nichia High-Power LEDs

DRIVER

Meanwell HLG Series Driver mounted with screws onto a raised rib casting within the luminaire end-caps; Contact factory for specifications.

EMERGENCY BATTERY BACKUP

Optional EM Battery Backup available on some configurations. Contact Factory for details.

MOTION SENSOR

Motion Sensor On/Off & Motion sensor with dimming (Bi-Level Dimming) available as options.

VOLTAGE

120-277V Input Standard, 347V/480V Input Available. THD <20% Power Factor >90%

DIMMING

0-10V Dimmable Driver is available as an option.

CONTROLS

Zigbee Connectivity is Available as an Option

OPERATING TEMPERATURE

-20C to 40C.

LUMEN MAINTENANCE

L70 Rating of over 150,000 Hours up to 40C

PHOTOMETRICS / AXIAL DIAGRAMS: 150W-40K

V: Front View
H: Side View

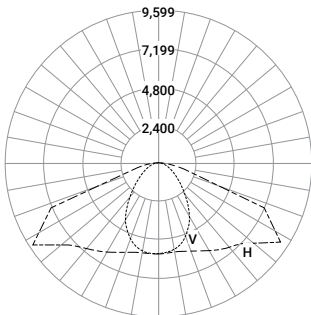

T1 - IES TYPE I DISTRIBUTION

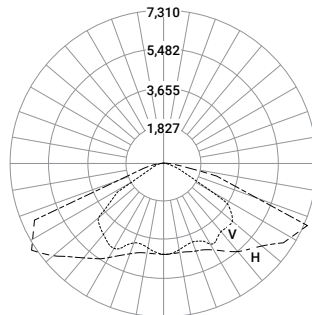

T2 - IES TYPE II DISTRIBUTION

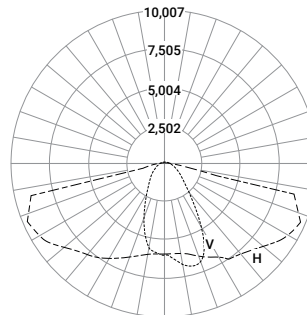

T3 - IES TYPE III DISTRIBUTION

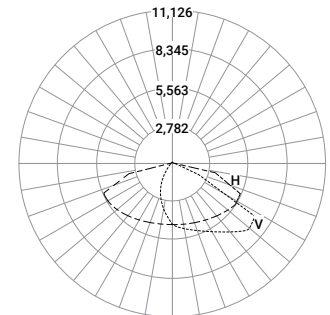

T4 - IES TYPE IV DISTRIBUTION

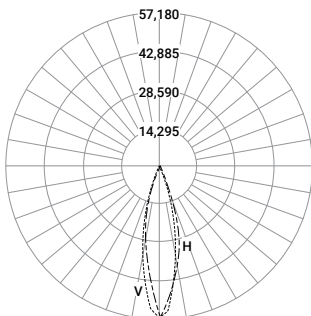

20D - IES TYPE V DISTRIBUTION - 20° BEAM ANGLE

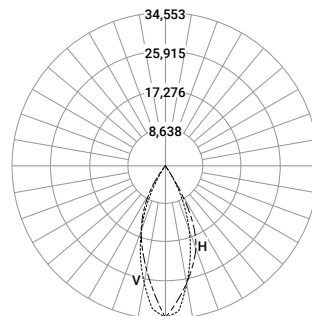

40D - IES TYPE V DISTRIBUTION - 40° BEAM ANGLE

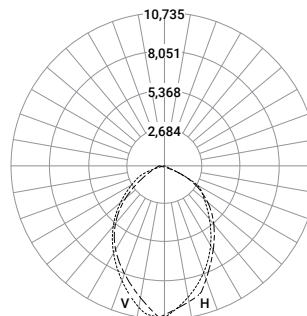

80D - IES TYPE V DISTRIBUTION - 80° BEAM ANGLE

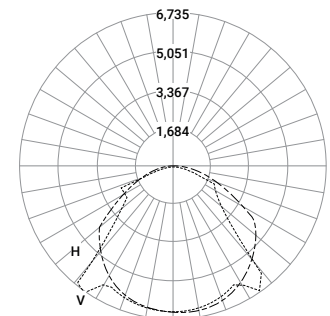

170D - IES TYPE V DISTRIBUTION - 170° BEAM ANGLE

FOR ADDITIONAL INFORMATION PLEASE DOWNLOAD IES FILES FROM WEBSITE