

HB490
LED HIGHBAY

PROJECT _____ DATE _____ TYPE _____
NOTES _____



REV: 02 2021

* Contact Paraflex for DLC Part Number



215W MODEL WITH NO LENS (STANDARD)



215W MODEL WITH OPTIONAL
DIFFUSE LENS

HIGH BAY

The HB490 series is a group of full-body, premium-performance LED high bay luminaries. These luminaries are designed to illuminate a wide variety of settings, including commercial, industrial and big-box retailers. With a painted, steel housing, the HB490 provides high levels of durability and performance. High-efficacy, long-life LEDs provide both energy and maintenance cost savings compared to traditional, High Intensity Discharge (HID) high bays.

120-277V STANDARD

PRODUCT APPLICATIONS

- Warehouses
- Sporting Venues
- Manufacturing Plants

When Specifying Options, Please Check with Factory for Availability and Lead-Time. Any modified product, any selected options added to standard products, deem order non-cancelable and non-returnable. All RMA, Return Material Authorization, must be factory approved.

ORDERING GUIDE Sample Part # HB490-90W-4K -WH

MODEL	WATTAGE	CCT	HOUSING COLOR	OPTIONS
HB490	90W 135W 180W 215W 265W 320W 425W	40K 4000K 50K 5000K	WH (STANDARD)	V1* 480/347V Input (120-277V Standard) * NOT AVAILABLE WITH EM OR MOTION SENSOR

ACCESSORIES (ORDER SEPERATELY) Sample Part # HB490-CR-LENS-12X23 + HB490-EM

ACCESSORY

- | | |
|---|---|
| <p>HB490-CRLENS-12X23 Clear lens – 90W, 135W & 180W</p> <p>HB490-CRLENS-17X23 Clear lens – 215W</p> <p>HB490-CRLENS-12x45 Clear lens – 265W & 320W</p> <p>HB490-CRLENS-17x45 Clear lens – 425W</p> <p>HB490-DIFLENS-12X23 Diffuse lens – 90W, 135W & 180W</p> <p>HB490-DIFLENS-17X23 Diffuse lens – 215W</p> <p>HB490-DIFLENS-12x45 Diffuse lens – 265W & 320W</p> <p>HB490-DIFLENS-17x45 Diffuse lens – 425W</p> <p>HB490-WG-12X23 Wire-guard kit – 90W, 135W & 180W</p> <p>HB490-WG-17X23 Wire-guard kit – 215W</p> <p>HB490-WG-12x45 Wire-guard kit – 265W & 320W</p> | <p>HB490-WG-17x45 Wire-guard kit – 425W</p> <p>HB490-SMK-12.625WIDE Surface-mount kit – 90W, 135W, 180W, 265W, 320W</p> <p>HB490-SMK-17.25WIDE Surface-mount kit – 215W & 425W</p> <p>HB490-PMK Pendant-mount kit – all models</p> <p>HB490-CMK3 Cable-mounting kit, 3 meters long</p> <p>HB490-CMK5 Cable-mounting kit, 5 meters long</p> <p>HB490-MS Motion Sensor</p> <p>HB490-EM Emergency Battery Pack</p> |
|---|---|

HB490

LED HIGHBAY

PARAFLEX
Fast Flexible Focused Lighting

PARAFLEX does not warrant or represent that the information is free from errors or omission. The information may change without notice and PARAFLEX is not in any way liable for the accuracy of any information printed and stored or in any way interpreted or used.

FEATURES

Available in 4000k (neutral white) and 5000k (cool white) color temperatures.

Long-life LEDs provide 122,000 hours of operation with at least 70% of initial lumen output (L70).

Universal 120-277 AC voltage (50-60Hz) is standard.

0-10vdc dimming drivers are standard.

Power factor > 0.90; Total harmonic distortion < 20%.

Color rendering index > 80.

Painted steel housings are standard.

Chain-mount kits (includes v-hooks and 1/8" thick, 1-meter long chain) are standard.

Accessories include lenses (clear & diffused), wire-guard kits, surface mounting kits, pendant-mounting kits, and cable-mounting kits.

Easy installation in new construction or retrofit.

MOUNTING KITS

Chain mounting with V-hooks is standard.

Optional surface mounting kits provides attachment to flat ceilings.

Optional pendant mounting kits provides pendant attachment to junction boxes.

Optional cable mounting kits provide suspension at two lengths (i.e., 3 & 5 meters).

WARRANTY & LISTINGS

cULus listed for damp locations in ambient temperatures from -20°C to 50°C (-4°F to 122°F).

DLC premium approved (Contact Paraflex for DLC Part number)

Flicker-free per IEEE1789-2015 (low risk of adverse effects of flicker at 100% light output level).

Complies with RoHS (Restriction on Hazardous Substances) requirements.

Complies with FCC Part 15, class A.

Complies with IEEE C.62.41-1991, input transient protection (2.5kV).

5-year warranty of all electronics and housing.

PRODUCT SPECIFICATIONS

Model	Color Temp	Lumens	Watts	Lumens / Watt	Input Current (A)		
					120V	240V	277V
HB490-90W-4K	4000k	12,193	87	140	0.73	0.36	0.31
HB490-90W-5K	5000k	12,394	87	142	0.73	0.36	0.31
HB490-135W-4K	4000k	18,401	132	139	1.10	0.55	0.48
HB490-135W-5K	5000k	18,564	132	141	1.10	0.55	0.48
HB490-180W-4K	4000k	24,457	175	140	1.46	0.73	0.63
HB490-180W-5K	5000k	24,603	175	141	1.46	0.73	0.63
HB490-215W-4K	4000k	29,929	213	141	1.78	0.89	0.77
HB490-215W-5K	5000k	30,356	213	143	1.78	0.89	0.77
HB490-265W-4K	4000k	37,590	267	141	2.23	1.11	0.96
HB490-265W-5K	5000k	37,996	267	142	2.23	1.11	0.96
HB490-320W-4K	4000k	44,235	320	138	2.67	1.33	1.16
HB490-320W-5K	5000k	44,460	320	139	2.67	1.33	1.16
HB490-425W-4K	4000k	59,278	428	139	3.57	1.78	1.55
HB490-425W-5K	5000k	60,629	428	142	3.57	1.78	1.55

HB490

LED HIGHBAY

PARAFLEX does not warrant or represent that the information is free from errors or omission. The information may change without notice and PARAFLEX is not in any way liable for the accuracy of any information printed and stored or in any way interpreted or used.

PHOTOMETRICS (STANDARD W/ NO LENS)

ISO footcandle plots depict initial foot candles at grade. Gridlines represent units of mounting height of 25 feet.

HB490-90W-5K (12,394 Lumens)

Candlepower Summary

0°	90°
0°	4,303
10°	4,274
20°	4,110
30°	3,767
40°	3,305
50°	2,713
60°	1,987
70°	1,176
80°	385
90°	0

Zonal Lumen Summary

Zone	Lumens	%Fixture
0° - 10°	406	3.3%
0° - 20°	1,582	12.8%
0° - 30°	3,397	27.4%
0° - 40°	5,614	45.3%
0° - 50°	7,947	64.1%
0° - 60°	10,069	81.2%
0° - 70°	11,644	94.0%
0° - 80°	12,313	99.3%
0° - 90°	12,394	100.0%
90° - 180°	0	0.0%
0° - 180°	12,394	100.0%

Cone of Light

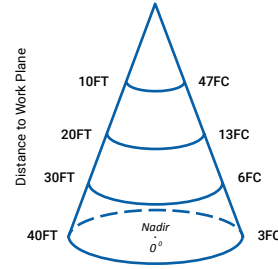

ISO Plot

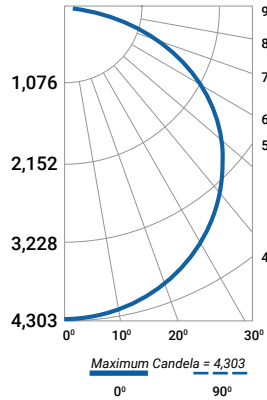
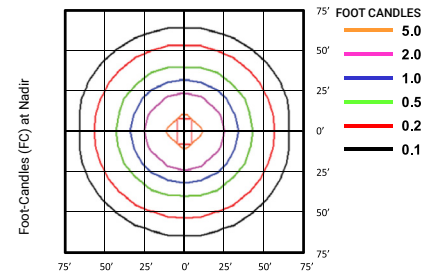

HB490-135W-5K (18,564 Lumens)

Candlepower Summary

0°	90°
0°	6,452
10°	6,398
20°	6,143
30°	5,642
40°	4,948
50°	4,006
60°	3,003
70°	1,772
80°	580
90°	0

Zonal Lumen Summary

Zone	Lumens	%Fixture
0° - 10°	610	3.30%
0° - 20°	2,377	12.80%
0° - 30°	5,110	27.50%
0° - 40°	8,470	45.60%
0° - 50°	11,998	64.60%
0° - 60°	15,214	82%
0° - 70°	17,465	94.10%
0° - 80°	18,441	99.30%
0° - 90°	18,564	100%
90° - 180°	0	0.0%
0° - 180°	18,564	100.0%

Cone of Light

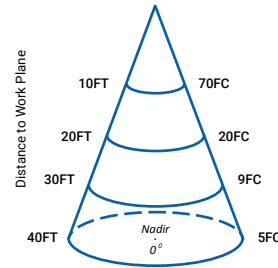

ISO Plot

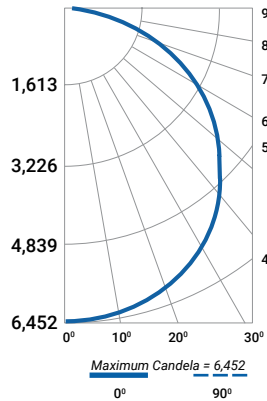
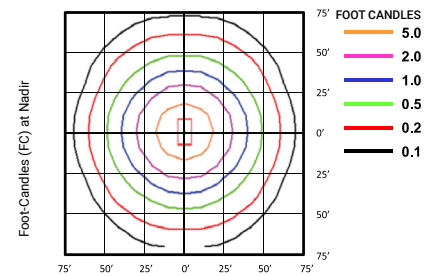

HB490-180W-5K (24,603 Lumens)

Candlepower Summary

0°	90°
0°	8,553
10°	8,487
20°	8,173
30°	7,487
40°	6,581
50°	5,425
60°	3,993
70°	2,383
80°	808
90°	0

Zonal Lumen Summary

Zone	Lumens	%Fixture
0° - 10°	809	3.30%
0° - 20°	3,155	12.80%
0° - 30°	6,787	27.60%
0° - 40°	11,259	45.80%
0° - 50°	15,964	64.90%
0° - 60°	20,185	82%
0° - 70°	23,093	93.30%
0° - 80°	24,441	99.30%
0° - 90°	24,603	100%
90° - 180°	0	0%
0° - 180°	24,603	100%

Cone of Light

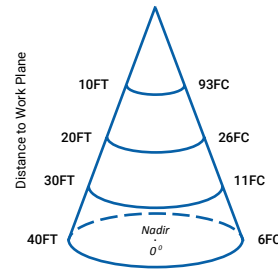

ISO Plot

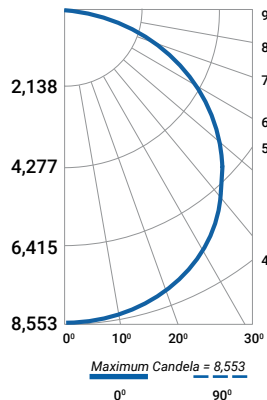
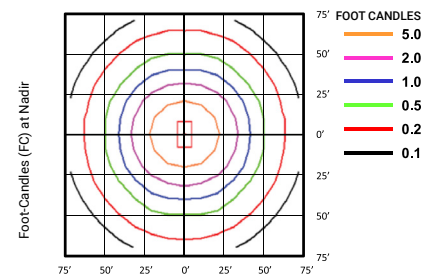

HB490

LED HIGHBAY

PARAFLEX does not warrant or represent that the information is free from errors or omission. The information may change without notice and PARAFLEX is not in any way liable for the accuracy of any information printed and stored or in any way interpreted or used.

PHOTOMETRICS CONT. (STANDARD W/ NO LENS)

ISO footcandle plots depict initial foot candles at grade. Gridlines represent units of mounting height of 25 feet.

HB490-215W-5K (30,356 Lumens)

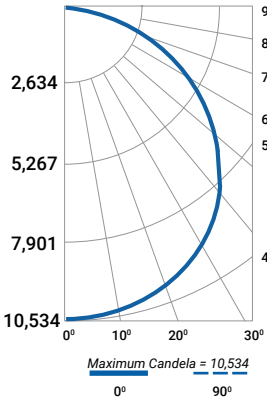

Candlepower Summary

0°	90°
0°	10,534
10°	10,446
20°	10,036
30°	9,191
40°	8,048
50°	6,605
60°	4,857
70°	2,885
80°	972
90°	0

Zonal Lumen Summary

Zone	Lumens	%Fixture
0°-10°	993	3.30%
0°-20°	3,870	12.70%
0°-30°	8,310	27.40%
0°-40°	13,770	45.40%
0°-50°	19,513	64.30%
0°-60°	24,683	81.30%
0°-70°	28,355	93.40%
0°-80°	30,118	99.20%
0°-90°	30,356	100.00%
90°-180°	0	0.00%
0°-180°	30,356	100.00%

Cone of Light

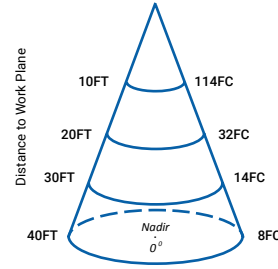

Distortion? (What can I call this graph?)

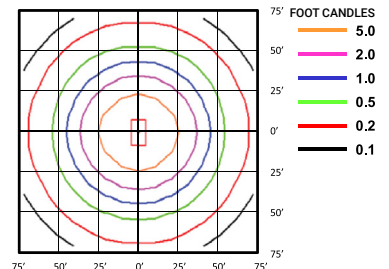

HB490-265W-5K (37,996 Lumens)

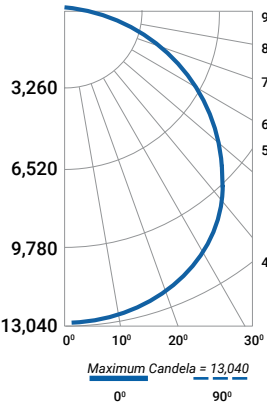

Candlepower Summary

0°	90°
0°	13,040
10°	12,940
20°	12,450
30°	11,488
40°	10,159
50°	8,449
60°	6,305
70°	3,864
80°	1,376
90°	0

Zonal Lumen Summary

Zone	Lumens	%Fixture
0°-10°	1,234	3.20%
0°-20°	4,813	12.70%
0°-30°	10,349	27.20%
0°-40°	17,160	45.20%
0°-50°	24,351	64.10%
0°-60°	30,907	81.30%
0°-70°	35,544	93.50%
0°-80°	37,692	99.20%
0°-90°	37,991	100.00%
90°-180°	5	0.00%
0°-180°	37,996	100.00%

Cone of Light

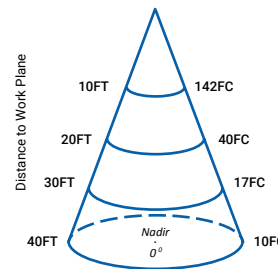

ISO Plot

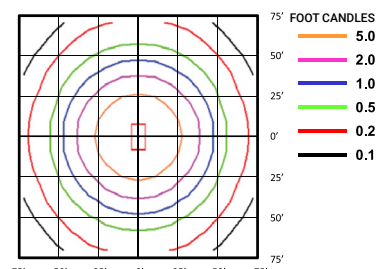

HB490-320W-5K (44,460 Lumens)

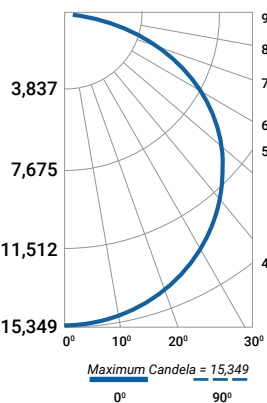

Candlepower Summary

0°	90°
0°	15,349
10°	15,202
20°	14,607
30°	13,474
40°	11,901
50°	9,818
60°	7,312
70°	4,456
80°	1,578
90°	0

Zonal Lumen Summary

Zone	Lumens	%Fixture
0°-10°	1,453	3.30%
0°-20°	5,665	12.60%
0°-30°	12,168	27.40%
0°-40°	20,153	45.30%
0°-50°	28,564	64.20%
0°-60°	36,216	81.50%
0°-70°	41,604	93.60%
0°-80°	44,106	99.20%
0°-90°	44,456	100%
90°-180°	4	0%
0°-180°	44,460	100%

Cone of Light

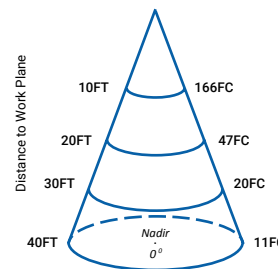

ISO Plot

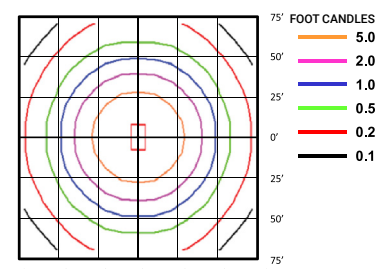

HB490

LED HIGHBAY

PARAFLEX does not warrant or represent that the information is free from errors or omission. The information may change without notice and PARAFLEX is not in any way liable for the accuracy of any information printed and stored or in any way interpreted or used.

PHOTOMETRICS CONT. (STANDARD W/ NO LENS)

ISO footcandle plots depict initial foot candles at grade. Gridlines represent units of mounting height of 25 feet.

HB490-425W-5K (60,629 Lumens)

Candlepower Summary

	0°	90°
0°	20,757	20,757
10°	20,548	20,583
20°	19,742	19,889
30°	18,239	18,567
40°	16,086	16,566
50°	13,307	13,877
60°	9,917	9,531
70°	5,987	5,317
80°	2,089	1,138
90°	0	30

Zonal Lumen Summary

Zone	Lumens	%Fixture
0° - 10°	1,962	3.20%
0° - 20°	7,645	12.60%
0° - 30°	16,413	27.10%
0° - 40°	27,217	44.90%
0° - 50°	38,652	63.80%
0° - 60°	49,008	80.80%
0° - 70°	56,412	93.00%
0° - 80°	60,036	99.00%
0° - 90°	60,600	100.00%
90° - 180°	29	0.00%
0° - 180°	60,629	100.00%

Cone of Light

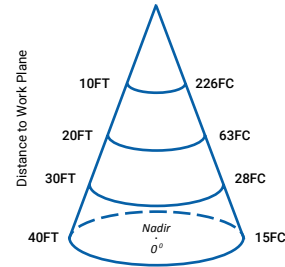

ISO Plot

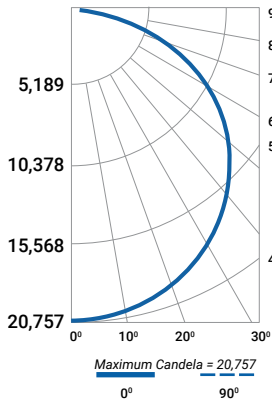
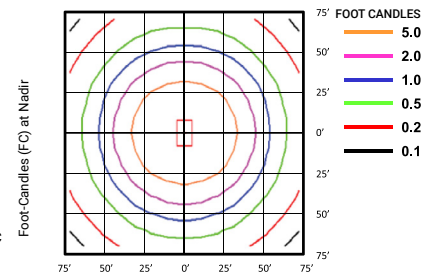

DIMENSIONS

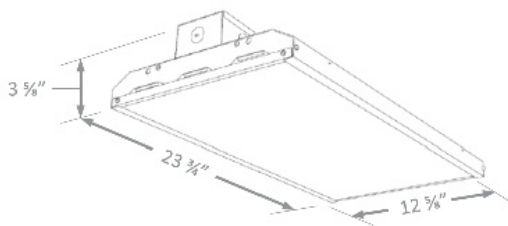

90 - 180W Models
(9.9 - 11.0 lbs.)

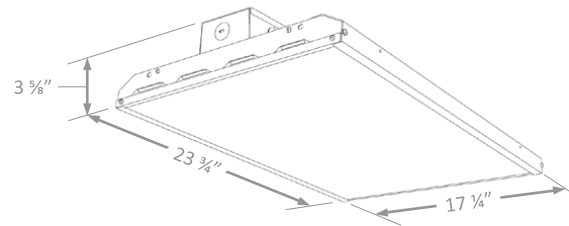

215W Model
(14.0 lbs.)

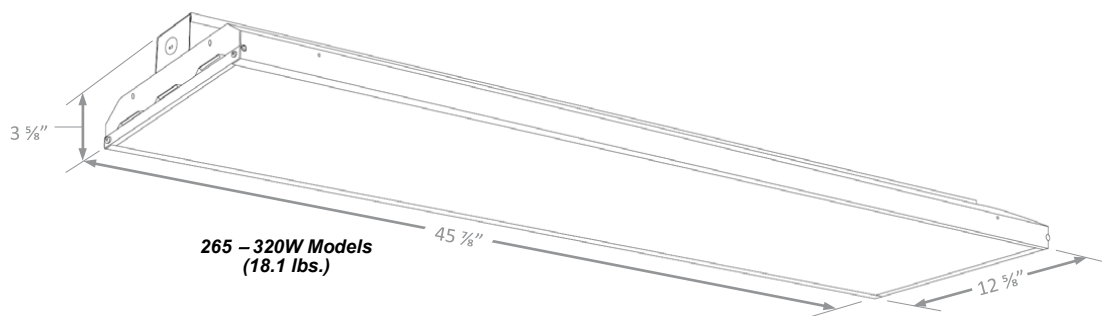

265 - 320W Models
(18.1 lbs.)

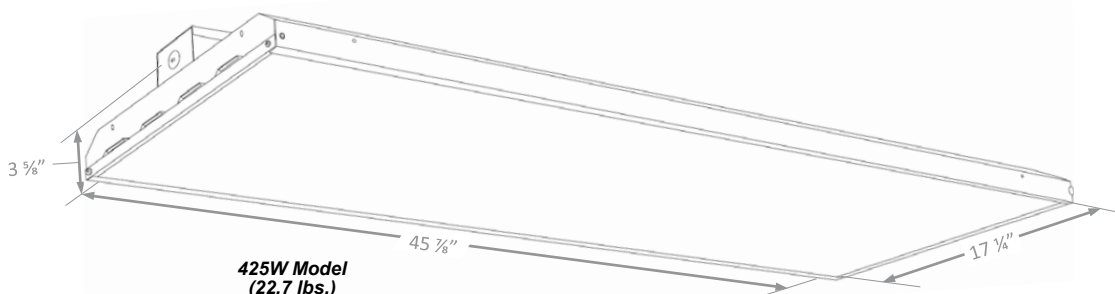

425W Model
(22.7 lbs.)